



OWNER'S MANUAL

V20
V20 PRO
iQ20

V20 V20 PRO iQ20

GENERAC MOBILE PRODUCTS S.r.l.

**Via Stazione, 3 bis
27030 Villanova d'Ardenghi (PV)
ITALY**

Tel.: +39 0382 567011

Fax: +39 0382 400247

Web site:

<https://www.towerlight.com/>

E-mail:

info@towerlight.com

INDEX

1.	INTRODUCTION	5
2.	GENERAL INFORMATION	5
3.	PRELIMINARY REQUIREMENTS	6
3.1	BEFORE USING THE MACHINE	6
3.2	PERSONNEL/USER REQUIREMENTS	6
4.	SAFETY SIGNS	7
5.	GENERAL DANGER INFORMATION	9
5.1	RISK OF ELECTROCUTION	9
5.2	RISK OF BURN	9
5.3	RISK OF ENTANGLING.....	9
5.4	FIRE-FIGHTING INFORMATION.....	9
5.5	FOR MACHINES EQUIPPED WITH COMBUSTION ENGINE	9
5.5.1	RISK OF FIRE OR EXPLOSION DURING REFUELING	9
5.5.2	RISK OF BURN	9
5.5.3	NOISE	9
5.5.4	EXHAUST GASES.....	9
6.	DISPOSAL OF WASTE ELECTRICAL AND ELECTRONIC EQUIPMENT	10
7.	NAMEPLATE	11
8.	LIMITATIONS OF USE	11
9.	SAFETY RULES TO OBSERVE	12
9.1	DURING TRANSPORTATION	12
9.2	DURING MAINTENANCE	12
10.	CONTROLS DESCRIPTION	13
10.1	COMMAND PANEL	13
10.2	MAINS SUPPLY (OPTIONAL)	15
10.3	GENERATOR/MAINS SELECTOR (OPTIONAL).....	16
10.4	WATER PRE-HEATING (OPTIONAL).....	16
10.5	FULL BUNDED TANK LIGHT INDICATOR (OPTIONAL)	16
11.	OPERATING INSTRUCTIONS	17
11.1	TRANSPORTATION.....	17
11.1.1	SLOW TOWING	17
11.1.2	FAST TOWING (OPTIONAL).....	18
11.2	POSITIONING	18
11.3	PRELIMINARY CHECKS.....	19
11.4	EARTHING	19
11.4.1	EARTHING REQUIREMENTS.....	19
11.4.2	NOTES	20
11.5	CONNECTING THE BATTERY.....	21
11.6	FUEL TANK.....	21
11.6.1	THE MANUFACTURER APPROVES THE USE OF HVO BIOFUEL	22
11.7	ENGINE OIL CHECK.....	22
11.8	COOLANT LEVEL CHECK (IF PRESENT)	22
11.9	STARTING THE ENGINE	23
11.10	GTL01	23

V20 V20 PRO iQ20

11.11	L401	24
11.12	PRO.....	24
11.13	RUNNING IN	27
11.14	STABILIZERS.....	27
11.15	MAST ADJUSTMENT	28
11.16	FLOODLIGHTS	28
11.17	ELECTRIC PROTECTION.....	29
11.18	STOPPING THE GENERATOR.....	30
11.19	TIME OF INACTIVITY	31
12.	MAINTENANCE	32
12.1	ENGINE.....	32
12.1.1	ENGINE OIL CHANGE	32
12.2	ALTERNATOR	33
12.3	MACHINE CLEANING	33
12.4	STABILIZERS.....	33
12.5	HYDRAULIC CYLINDER	33
12.6	HYDRAULIC GEAR BOX.....	33
12.7	HYDRAULIC CONNECTIONS.....	33
12.8	STEEL CABLES	33
13.	TROUBLESHOOTING	34
13.1	TROUBLESHOOTING GUIDE.....	34

V20 V20 PRO iQ20

1. INTRODUCTION

Dear Customer, thank you for purchasing our product. This manual contains all the necessary information for the use and general maintenance of the machine.

Before installing the machine and in any case before operating it, read carefully this use and maintenance manual. In case any information is not clear or perfectly understandable, please contact us.

This manual is an integral part of the machine and must therefore follow the machine's life cycle for 10 years after commissioning, even when the machine has to be transferred to different users.

The operator is responsible for the proper use of the machine.

All data and photographs in this catalog may be subject to change without notice.

2. GENERAL INFORMATION

This machine is designed, built and tested to meet current European regulations, which ensure state-of-the-art performance and minimum safety hazards.

The standard documentation package of a product includes:

- safety information guideline;
- owner's manual;
- engine manual (if present);
- alternator manual (if present);
- controller manual (if present)
- wiring diagram;
- spare parts list;
- installation drawing;
- CE declaration (when applicable);
- warranty sheet.

These documents may be provided in electronic form (in a USB stick or through the manufacturer's website) in accordance with ISO 12100:2010, 6.4.5.

The product's dimensions, mass value and position of the center of gravity are reported in the installation drawing.

For additional technical specifications please refer to the manufacturer's website.

The manufacturer disclaims any liability arising from the modification of the product and not explicitly authorized.

To guarantee the efforts made to maintain high quality standards in products, processes and managerial practices, the manufacturer obtained the ISO 9001 certification.



The CE (European Community) mark certifies that the product complies with essential safety requirements provided by the applicable Community Directives.

V20 V20 PRO iQ20

3. PRELIMINARY REQUIREMENTS

The manufacturer is not responsible for any damage to persons and property resulted from ignoring safety rules.

3.1 BEFORE USING THE MACHINE

Read carefully the safety signs on the machine.

Perform a specific assessment of the installation site.

Define a work area with suitable restrictions to keep unauthorized personnel away.

Always leave proper space around the machine.

It is recommended to place the machine on a stable place, checking the consistency of the soil to provide safe support to the stabilizers.

Before operating the machine, it is advisable to perform a general visual check; attention shall be paid to all moving parts, which can be subjected to wear.

Before operating on the machine, make sure it is off and that there are no moving parts.

3.2 PERSONNEL/USER REQUIREMENTS

Installing and operating the machine may imply work with dangerous currents and voltages. Therefore, only authorized personnel who knows the risks involved in working with electrical equipment should install and operate the machine.

Users in charge of the machine operation should be informed regarding electrical hazards. Users shall be skilled or instructed/informed, not unqualified personnel.

A skilled person is one with technical knowledge or sufficient experience to enable him or her to avoid the dangers which electricity may create.

An instructed/informed person is one adequately advised or supervised by a skilled person to enable him or her to avoid the dangers which electricity may create.

An unqualified person is a person who is neither skilled nor instructed.

Users in charge of the machine operation shall have read and fully understood the use and maintenance manual. They shall refer to all prescriptions in the document.

Users in charge of the machine operation shall carefully read safety labels and safety plates on the machine.

Users in charge of the machine operation shall be equipped with Personal Protective Equipment (PPE).







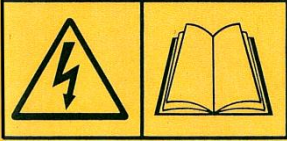

Only authorized personnel, who understand the risks deriving from failures and anomalies that might occur, should install and operate the machine.

V20 V20 PRO iQ20



4. SAFETY SIGNS





There are labels on your equipment that contain important information and safety instructions. These signs warn the user about any dangers which can be harmful to people, property or the machine itself.

Read the explanations and precautions described in the manual.

Danger signs	Meaning
	<ul style="list-style-type: none"> • Risk of electric shocks. • Read the manual.
	<ul style="list-style-type: none"> • Health-harmful exhaust gases. • Keep a distance from the emission zone.
	<ul style="list-style-type: none"> • Risk of burns. • Do not touch the exhaust parts and engine when the machine is working.
	<ul style="list-style-type: none"> • Danger: do not open when the engine is hot.
	<ul style="list-style-type: none"> • Stop the engine before refueling it. • Use diesel only.
	<ul style="list-style-type: none"> • Risk of possible corrosive spills.
	<ul style="list-style-type: none"> • Risk of crushing hands.
	<ul style="list-style-type: none"> • Please ensure stabilizers are extended, adjusted and securely tightened before retracting the jockey wheel assembly.

V20 V20 PRO iQ20

Prohibition signs	Meaning
	<ul style="list-style-type: none"> Do not clean, lubricate or register parts in motion.
	<ul style="list-style-type: none"> Do not extinguish fires with water, use proper fire extinguishers.
	<ul style="list-style-type: none"> Do not approach with free flames.

Information signs	Meaning
	<ul style="list-style-type: none"> Read the instruction manual before using the machine
	<ul style="list-style-type: none"> Location of a lift point
	<ul style="list-style-type: none"> Lift points with forklift
 <div data-bbox="379 1525 691 1619" style="background-color: yellow; padding: 5px; display: inline-block;"> <p>KEEP FEET CLEAR OF TOWING ASSEMBLY</p> </div>	<ul style="list-style-type: none"> Keep feet clear of towing assembly.

V20 V20 PRO iQ20

5. GENERAL DANGER INFORMATION

5.1 RISK OF ELECTROCUTION

The machine can produce dangerous electrical voltages and cause deadly electric shocks. Connecting to the power grid also involves dangerous tensions.

Avoid contact with exposed wires, terminals, connections while the unit is running. Make sure that all the covers and barriers you have prepared are up and running and in place before using the machine. If it is needed to work on a machine while it is activated, stand on an isolated dry surface to reduce the risk of electric shocks

DO NOT handle any type of electrical device while standing on water, while barefoot or while your hands and/or feet are wet, this could cause DANGEROUS electric shocks.

In the event of an accident caused by electric shock, immediately turn off the electricity source.

If this is not possible, try to free the victim from the active conductor. Avoid direct contact with the victim. Use non-conducting material (e.g. wood) to free the victim from the active conductor. If the victim is unconscious, apply first aid procedures and call medical assistance immediately.

5.2 RISK OF BURN

Avoid contact with the floodlights when operating lighting towers.

Use appropriate Personal Protective Equipment (PPE) when operating the machine.

5.3 RISK OF ENTANGLING

Do not remove protections placed on rotating parts, air intakes and belts.

Do not clean or perform any maintenance on moving parts.

Use appropriate Personal Protective Equipment PPE when operating the machine.

5.4 FIRE-FIGHTING INFORMATION

In case of fire it is recommended to use a powder extinguisher with fire class 13A 89B C.

5.5 FOR MACHINES EQUIPPED WITH COMBUSTION ENGINE

5.5.1 RISK OF FIRE OR EXPLOSION DURING REFUELING

Always turn off the machine before refueling.

Do not smoke during refueling.

The refueling operation must be carried out in order not to spill fuel from the tank.

In the event of a fuel leak, dry and clean the parts.

Verify that there are no fuel leaks and that the pipes are intact.

5.5.2 RISK OF BURN

Avoid contact with hot surfaces, such as mufflers and their extensions or the engine body when it is running.

Use appropriate Personal Protective Equipment (PPE) when operating the machine.

5.5.3 NOISE

Use proper Personal Protective Equipment (PPE) for acoustic protection.

5.5.4 EXHAUST GASES

Exhaust gases are harmful to health. Keep a safe distance from the emission zone.

V20 V20 PRO iQ20

6. DISPOSAL OF WASTE ELECTRICAL AND ELECTRONIC EQUIPMENT

Professional disposal of this machine avoids negative effects on human health and the environment, helps with the targeted treatment of pollutants and makes it possible to recycle valuable raw materials.

FOR CUSTOMERS IN EU COUNTRIES

This machine is subject to the European directive for old electrical and electronic equipment (Waste Electrical and Electronic Equipment WEEE), as well as the corresponding national laws. The WEEE directive provides the framework for an EU-wide treatment of old electrical equipment.



The machine is marked with the following symbol of a crossed-out garbage bin. This means that the machine can not be disposed in normal household waste but that it must be disposed of in a separate, environmentally friendly collection facility.



This unit is provided as a professional electrical tool exclusively for commercial use (a so-called B2B device according to the WEEE directive). Unlike equipment mostly used in private households (so-called B2C devices), this machine may therefore not be disposed of in some EU countries at the collection points of public waste management organizations (e.g. municipal collection stations). If there are any doubts, information regarding the different methods of disposal for B2B electronic devices for each country can be obtained from the sales location, so that the disposal takes place in accordance with the valid statutory provisions. There are also some notes to follow in the sales contract or in the general Terms and Conditions of the sales location.

FOR CUSTOMERS IN OTHER COUNTRIES

It is recommended that you do not dispose of the machine in normal household waste but rather in a separate, environmentally friendly collection facility. National laws also may, under certain circumstances, prescribe the separate disposal of electrical and electronic products. Correct disposal of this machine in accordance with current national guidelines must be assured.

V20 V20 PRO iQ20

7. NAMEPLATE

1		2	3
		4	
Generating set ISO 8528	8	Model / Type :	9
Rated Power COP (kVA):	10	Rated Power COP (kW):	11
Frequency (Hz) / RPM:	12	Power factor (cosphi):	13
Voltage (V):	14	Current (A):	15
Class:	16		
Mass (Kg):	17		
Serial Number:	18	Manufacturing Year:	19
		6	
7		5	

- | | |
|--|-------------------------------|
| 1. trademark of the manufacturer | 11. rated power, in kilowatts |
| 2. QR code with link to the documents download webpage | 12. rated frequency, in hertz |
| 3. regulatory marks | 13. rated power factor |
| 4. country of construction | 14. rated voltage |
| 5. contacts of the manufacturer | 15. rated current, in Amperes |
| 6. serial number barcode | 16. performance class |
| 7. name and address of the manufacturer | 17. mass in kilograms |
| 8. designation of the machinery | 18. serial number |
| 9. designation of series or type | 19. year of construction |
| 10. rated power, in kilo-Volt-Amperes | |

The machine has been set by the manufacturer for optimal performance at the rated working conditions reported in the nameplate. The working conditions shall not be adjusted unless in case of malfunction by authorized personnel.



The A-weighted sound power level (L_{WA} in accordance with ISO 8528-10:1998) emitted by the machine is reported in the CE declaration (when applicable) and affixed to the machine on adhesive supports.

8. LIMITATIONS OF USE

The machine is intended for use as a lighting device and an electricity generator only if originally provided with an electrical output socket, within the rated working conditions reported in the nameplate. Any use which differs from what here reported (misuse) is prohibited.

The manufacturer is not responsible for any damage to people and property resulting from misuse.

Use the machine within the standard permissible environmental temperatures:

- -10°C (14°F) to +45°C (113°F)

Do not use the machine at locations where the risk of fire or explosion may be high, such as on or near flammable materials and in presence of flammable or explosive gases.

Do not allow the use of the machine to unqualified personnel.

V20 V20 PRO iQ20

Some options may extend the permissible environmental conditions, please refer to the dedicated chapters.

9. SAFETY RULES TO OBSERVE

9.1 DURING TRANSPORTATION

Use **EXCLUSIVELY** the dedicated lift points, where present.

The lifting hook, where present, should be used exclusively for temporary lifting and not to keep the machine suspended for a long time.

The manufacturer is not liable for any damage caused by negligence during transport operations.

9.2 DURING MAINTENANCE

Maintenance operations shall be performed on the unit at rest.

Only authorized, skilled personnel shall perform ordinary and extraordinary maintenance.

Before any replacement or maintenance on the floodlights, remove the power supply and wait for the lamps to cool down.

Maintenance personnel shall be equipped with proper Personal Protective Equipment (PPE).

The battery may contains sulfuric acid, extremely corrosive and harmful for the skin. Always use protective gloves and use extreme caution when pouring liquid, being careful not to overflow.

Contact with motor oil can be harmful to the skin. Wear gloves before using oil. If you come in contact with oil, wash immediately.



Identify the draining points available in the machine and prepare suitable collection devices in order to avoid dangers related to spills and leaks.

Collect and dispose residual fluids such as fuel, oil and coolant according to local regulations, considering to avoid dangers to people and the environment.



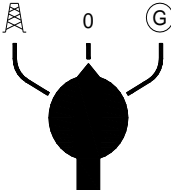
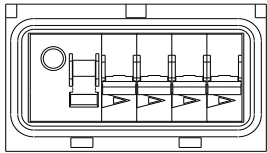
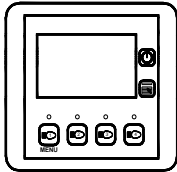

V20 V20 PRO iQ20

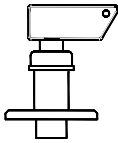
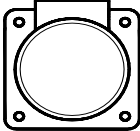
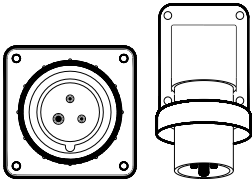
10. CONTROLS DESCRIPTION

10.1 COMMAND PANEL

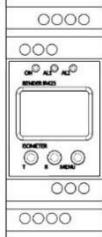
Item	Description
	Switch (if present)
	Main generator selector (if present)
	RCBO combined RCD/MCB device
	Controller
	Mast raising/lowering button
	Emergency stop button
	Battery isolator switch
	Auxiliary single-phase socket (if present)
	Single-phase male plug (if present)

V20 V20 PRO iQ20

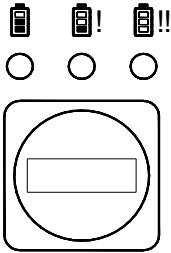
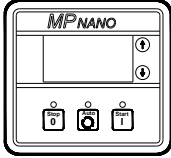
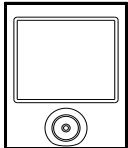
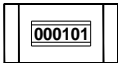
	<p>Isometer (if present)</p>
	<p>Light dependent relay (if present)</p>
	<p>Main Earth Terminal</p>
	<p>Full bunded tank light indicator (if present)</p>
<p>SPECIFIC FOR V20 PRO</p>	
	<p>Storage battery status indicator</p>
	<p>Controller</p>
	<p>Digital timer</p>
	<p>Hour counter</p>

V20 V20 PRO iQ20

	<p>Operating mode selector</p>
	<p>Control mode selector</p>
	<p>Floodlights dimming selector</p>

The light tower and single-phase auxiliary socket can be used at the same time. It is recommended not to exceed the plate data.

Use plugs that fit the socket and have the same characteristics.

The minimum section of the connection cable must be selected in relationship to the voltage, to the installed power and the distance between source and utility.

10.2 MAINS SUPPLY (OPTIONAL)

If the light tower is equipped with generator/mains selector, the power to the floodlights can be provided through the 230÷240 V domestic mains. Ensure the supply line is provided with adequate RCD and MCB protection.



Connect to the male plug , a socket with the same characteristics.

Warning!

The connection has to be as shown in the following image.

EEC version

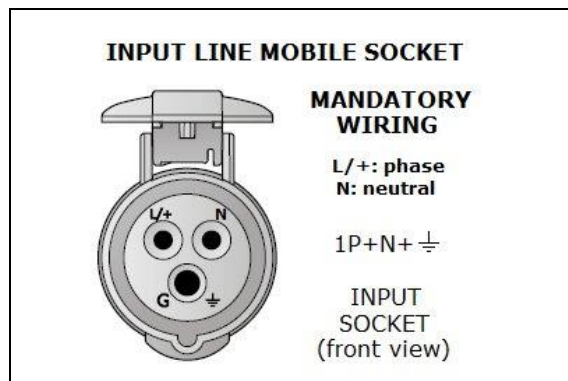

V20 V20 PRO iQ20

The minimum section of the connection cable must be selected in relationship to the voltage, to the installed power and the distance between source and utility.

Make sure that all circuit breakers and RCD are engaged.

10.3 GENERATOR/MAINS SELECTOR (OPTIONAL)

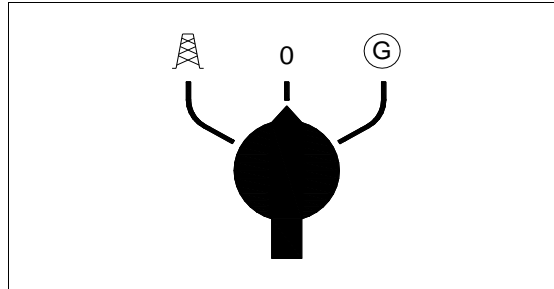

To feed the light tower by the electrical main place the selector on the “Mains” position.

To feed the light tower by the generator place the selector on “Generator” position.

10.4 WATER PRE-HEATING (OPTIONAL)

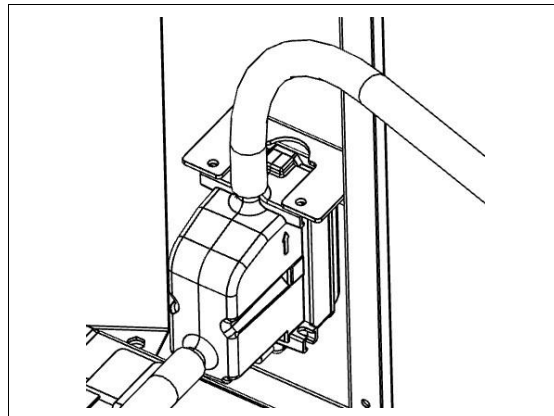

If the light tower is equipped with water pre-heating system, the power to the heater can be provided through the 230÷240 V domestic mains.



Connect to the male plug , a socket with the same characteristics as described at the dedicated chapter.

This option extends the minimum permissible environmental temperature to -20 C°(-4°F)

10.5 FULL BUNDED TANK LIGHT INDICATOR (OPTIONAL)

Empty the banded tank when the indicator   lights up. Remove the banded tank cap placed under the base. **Do not discharge polluting liquids in the atmosphere.**

V20 V20 PRO iQ20

11. OPERATING INSTRUCTIONS

11.1 TRANSPORTATION

It is possible to lift the machine with a forklift through the dedicated openings in the base frame:

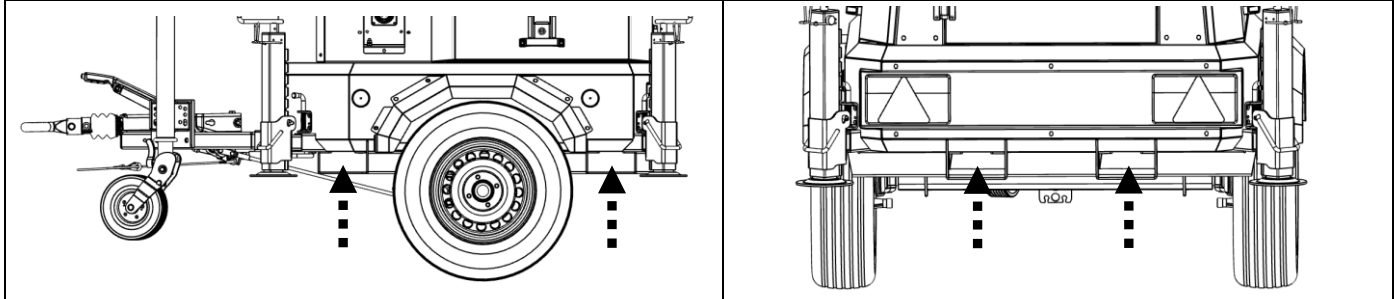

It is also possible to lift the machine using the central lifting hook on the canopy:

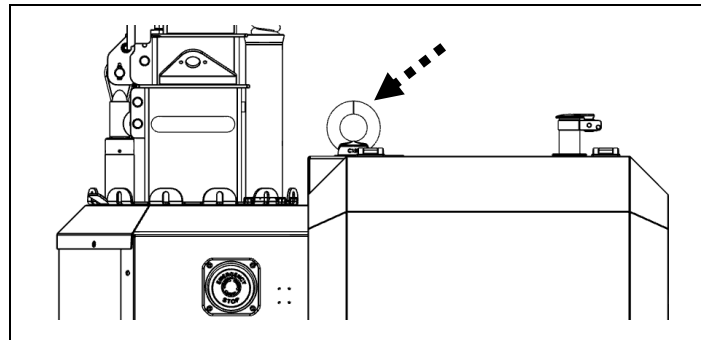

Verify the available lifting points on the installation drawing provided with the machine.

WARNING! the machine should be lifted only for transport. NEVER leave the machine suspended for longer time.

When positioning the tower, make sure to adjust the stabilizers.

11.1.1 SLOW TOWING

COUPLING INSTRUCTIONS

- Apply wheel chocks to prevent the trailer from moving.
- Make sure the towing vehicle is parked with engine off and with handbrake engaged.
- Use the front stabilizer to raise the coupling head above the hook of the towing vehicle.
- Couple the trailer to the towing vehicle.
- Retract the stabilizers.
- Remove wheel chocks and handbrake before starting to drive.

DECOUPLING INSTRUCTIONS

- Apply wheel chocks to prevent the trailer from moving.
- Make sure the towing vehicle is parked with engine off and with handbrake engaged.
- Deploy the stabilizers.
- Unhook the coupling head.
- Remove wheel chocks.

V20 V20 PRO iQ20

11.1.2 FAST TOWING (OPTIONAL)

COUPLING INSTRUCTIONS

- Apply wheel chocks or engage the trailer handbrake (if available) to prevent the trailer from moving.
- Make sure the towing vehicle is parked with engine off and with handbrake engaged.
- Use the jockey wheel⁽¹⁾ to raise the coupling head above the hook of the towing vehicle.
- Couple the trailer to the towing vehicle.
- Retract the jockey wheel until it is fully wound up.
- Sling the safety cable (if available) on the hook of the towing vehicle.
- Connect the electrical connections to the towing vehicle and check that the lights are working properly.
- Retract the stabilizers.
- Remove wheel chocks and handbrake before starting to drive.

DECOUPLING INSTRUCTIONS

- Apply wheel chocks or engage the trailer handbrake (if available) to prevent the trailer from moving.
- Make sure the towing vehicle is parked with engine off and with handbrake engaged.
- Remove the safety cable (if available) from the hook of the towing vehicle.
- Lower the jockey wheel⁽¹⁾.
- Disconnect the electrical connections.
- Deploy the stabilizers.
- Unhook the coupling head.
- Remove wheel chocks.

(1)

When coupling or uncoupling the light tower to/from vehicles, make sure to follow these indications:

- Know the type of jockey wheel and understand its correct locking mechanism.
- Verify that the locking mechanism is fully engaged before releasing the trailer from the towing vehicle.
- Pay attention to ground clearance if the towing vehicle is loaded with other equipment or materials, or if the ground level is uneven.
- Make sure that the operator's feet are clear of the trailer framework while the unit is hooked or unhooked.

11.2 POSITIONING

It is recommended to place the machine on a stable place, checking the consistency of the soil to provide safe support to the stabilizers.

Pull the hand brake if the tower is provided with trailer for fast towing.

Choose an open and ventilated location to ensure exhaust gases are released away from the work area.

Verify that there is complete air replacement and that the hot air is expelled and does not recirculate in the generator set in order to avoid dangerous temperature rise.

V20 V20 PRO iQ20

11.3 PRELIMINARY CHECKS

At the moment of purchase the machine is provided with engine oil and coolant in the radiator (if present).

Before every next use, check the relevant levels.

Check that the switches on the RCD/MCB device  are all in "OFF" position.

Make sure that no load is connected to the single-phase auxiliary socket .

Make sure the emergency stop button  is re-armed. If not, turn the button clockwise.

11.4 EARTHING

If necessary, connect the machine to ground using the MET (main earth terminal) .

The ground conductor must have a section of no less than 6 mm².

The manufacturer is not responsible for any damage caused by failing to connect the machine to ground.

Prescriptions and requirements to be fulfilled are as follows.

11.4.1 EARTHING REQUIREMENTS

Grounding must be carried out in accordance with the regulations at the site where the unit is operated. It is the responsibility of the user to determine the requirements and/or applicability of the local legislation concerning ground installations.

Grounding must be supervised or carried out by skilled and experienced personnel in accordance with local regulations.

Grounding must be of robust construction and maintained intact to ensure its proper functionality and the health and safety of personnel and surrounding environment.

The unit is provided with additional protection via a differential switch (RCD); one of the two poles of the single-phase generator, together with the metal parts that make up the machine, are connected to the main earth terminal (MET).

Requirement in compliance with BS 7430.2011 regulations:

Grounding in the UK must be carried out according to the requirements of the BS 7430:2011 standard. The machine should be connected to earth whenever possible, even if it is not mandatory for generators with nominal power under 10kW.

The manufacturer recommends to connect the MET (main earth terminal) on the machine to true earth through the grounding conductor.

Examples of ground connection. The following are examples of acceptable methods:

- (1) an earthing rod pushed to a suitable depth;
- (2) the earth terminal of an adjacent fixed installation;
- (3) permanent structural metalwork;
- (4) exposed reinforcement bars in foundations or concrete structures;
- (5) a suitable metal structure that is certain to be grounded.

V20 V20 PRO iQ20

The ground conductor must have a section of no less than 6 mm².

The resistance of such conductor must not be greater than 0.2 Ohm, including contact resistances.

An instructed/informed person should regularly verify the condition of the grounding conductor. Damage and/or disruption of the grounding conductor could lead to danger.

11.4.2 NOTES

As required by the IEC 60364, HD 60364, the ground conductor has been sized (like the protective conductors) as shown by the table below.

Cross-sectional area of line conductor S (mm ²)	If the protective conductor is of the same material as the line conductor (mm ²)
S ≤ 16	S
16 ≤ S < 35	16
S > 35	S/2

Residual current devices (RCDs) can be used for 2 purposes on the unit, namely:

- (1) to monitor the insulation of the system that has a metal structure containing the (isolated) conductors of the circuit;
- (2) to protect people in the event of contact between an active conductor and earth or a metal structure.

Point (2) above requires the electrical system to be referenced to earth to allow an RCD to operate properly on the first fault to the true ground.

Ground resistance, if possible, should not exceed 200 Ohm to ensure a cautionary margin. Earthing rods with the highest practicable depth should be preferred to ensure the highest installation safety.

For example, the resistance of an earthing rod can be calculated with the following formula:

$$R_r = \frac{\rho}{2\pi L} \left[\log_e \left(\frac{8L}{d} \right) - 1 \right]$$

Where:

ρ is the resistivity of the ground, in ohm meters (Ωm);

L is the length of the electrode, in meters (m);

d is the diameter of the rod, in meters (m).

When ground resistivity is not measurable, refer to the following table.

V20 V20 PRO iQ20

Type of soil	Climatic condition			
	Normal and high rainfall, i.e. > 500 mm/year		Low rainfall and desert conditions, i.e. < 250 mm/ year	Underground waters (saline)
	Probable value	Range of values encountered	Range of values encountered	Range of values encountered
1	2	3	3	5
Alluvium and lighter clays	5	A)	A)	1-5
Clays (except alluvium)	10	5-20	10-100	1-5
Marls (e.g. Keuper marl)	20	10-30	50-300	—
Porous limestone (e.g. chalk)	50	30-100	—	—
Porous sandstone (e.g. Keuper sandstone and clay shales)	100	30-300	—	—
Quartzite, compact and crystalline limestone (e.g. carboniferous sediments, marble, etc.)	300	100-1 000	—	—
Clay slates and slaty shales	1 000	300-3 000	1 000 upward	30-100
Granite	1 000	—	—	—
Fissiles shales, schists, gneiss and igneous rocks	2 000	1 000 upward	—	—

^{A)} Depends on water level of locality.

11.5 CONNECTING THE BATTERY

The machine is supplied with the battery disconnected.



Connect the battery with the supplied cables paying attention to the right polarity.



If the machine is equipped, connect the battery isolator switch

WARNING!!! Battery isolator switch shall be operated only while the machine is turned off. DO NOT operate the battery isolator switch while machine is working. This could result in system damage.

11.6 FUEL TANK

Fill up the tank according to its capacity. The instrument  or  on the control panel indicates the fuel level in the tank.

Always turn off the engine before refueling.

The refueling operation must be carried out in order not to spill fuel from the tank.

V20 V20 PRO iQ20

11.6.1 THE MANUFACTURER APPROVES THE USE OF HVO BIOFUEL

HVO (Hydrotreated Vegetable Oil) is a linear-chain paraffin fuel free of aromatics, oxygen and sulphur. With a high cetane number, it does not contain fatty acid methyl esters (FAME), therefore it can reduce NOx, THC and CO emissions

The units manufactured are equipped with internal combustion engines, must be powered by fuels in compliance with the UNI EN 15490 standard, European Directive 98/70/EC, CEN standard for diesel fuel EN 590, and American standard ASTM D975 for diesel fuel.

HVO is already commonly present in Diesel fuel in a 7-to-10% amount

The use of HVO fuel is also allowed to a 100% extent in compliance with current regulations. HVO fuel, however, has a 6% lower density than traditional fuel - a reduction which could affect performance and maintenance intervals.

The manufacturer is not responsible for any lower performance associated with the use of HVO fuel and recommends adhering to the engine manufacturers' instructions about the % to be used and the relevant maintenance work.

11.7 ENGINE OIL CHECK

Verify the position of the engine oil cap and of the oil level indicator in the engine use and maintenance manual, provided with the light tower.

Check the oil level of the engine before starting, or more than 5 minutes after shutdown.

11.8 COOLANT LEVEL CHECK (IF PRESENT)

To top up and replace the coolant, open the radiator cap or inspection door.

The coolant, if fully refilled before starting the engine, lasts for a workday; the coolant level must be regularly checked before every operation.

To avoid injuries, do not remove the radiator cap when the engine is hot. Once the engine has cooled down, slightly loosen the cap until it stops to discharge the excess pressure, and then remove it completely.

V20 V20 PRO iQ20

11.9 STARTING THE ENGINE



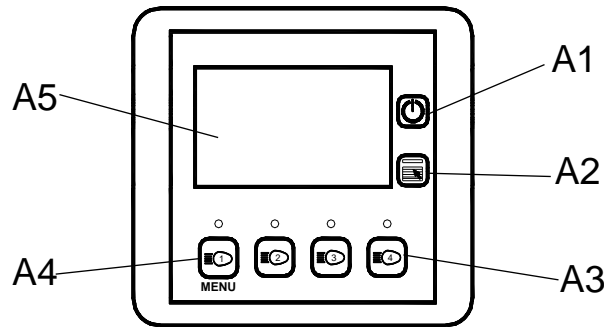

11.10 GTL01





Items	Description
A1	Start/Stop button
A2	Manual/Auto button
A3	On/Off lamps button
A4	Lamps status
A5	Graphic display

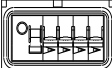

Two different operation modalities and two different control modes are managed by the control panel:

- Operations modalities:
Generator or Mains
- Control Modes:
Manual or Automatic

Switch "ON" (I) position  to enable the control panel or turn the selector  to "GENERATOR"  or "MAINS" .





Switch "ON" (I) the RCD and all circuit breakers  on the control panel.

Press the button (A2) in Manual Mode . The default Operation mode setting is the Manual mode.

Press Start/Stop button (A1)  to start the engine. Press Lamp On/Off (A3) ... buttons to switch On the lamps.

The lamps shall not switched on simultaneously, but with a delay between one and the other.

The Lamps Status (A4) blink during the delay time, they stops to blink when the delay is expired and the lamps are switched on.

Press the button (A2) in Automatic Mode, the icon  is substituted by the icons enabled:  for Light Sensor,  for Timer,  for Remote Start.

It is possible to enable one or more options, depending on which are available.

For complete description refer to the **GTL01 controller manual**.

V20 V20 PRO iQ20

11.11 L401

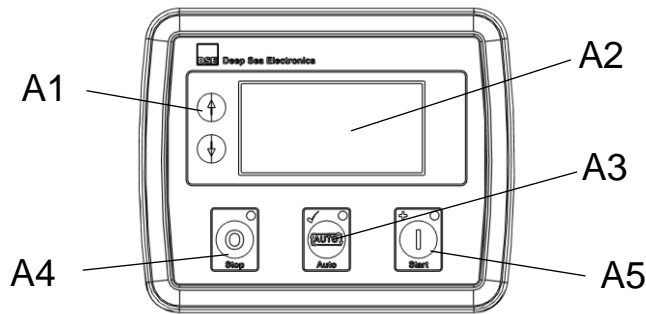

Items	Description
A1	Menu sliding
A2	Graphic display
A3	Button: manual / automatic
A4	Arrest button
A5	Start button

The basic functions are like those described in the previous paragraph. Timer functions must be set in the control unit and in automatic start mode. To enable the darkness sensor with automatic unit start, place the relative manual switch on "On" (I)

For a complete description, consult the **L401 MKII control unit manual..**

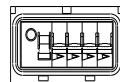

11.12 PRO



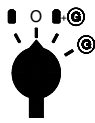

Switch "ON" (I) the RCD and all circuit breakers on the control panel.



- Through the selector it is possible to choose the desired operating mode.





 Off	System inactive, at rest, mains input and generator line disconnected.
 Hybrid	<p>In this operating mode:</p> <p>a. If available and mains power supply connected:</p> <ol style="list-style-type: none"> 1) This has higher priority and supplies the load (the LEDs) 2) The battery is charged and/or maintained in charge/floating. 3) The generator is kept at rest <p>b. If no mains power supply is available or not connected:</p> <ol style="list-style-type: none"> 1) The battery has higher priority and powers the load (the LEDs) 2) If the state of charge of the battery falls below a certain threshold, the generator is started to power the load and charge the battery 3) If the battery charge status is restored, the generator returns at rest and the battery powers the load. <p>c. If, during phase "b2", the mains is restored and/or connected, the generator will not be turned off.</p>

V20 V20 PRO iQ20

	<p>If it isn't possible to complete the battery charge with the generator, turn the selector to "off" and wait for engine shutdown. Subsequently turn the selector to "hybrid" and refer to phase "a".</p>
 Battery Only	<p>In this operating mode the control panel is switched off and the generator is forced at rest:</p> <ol style="list-style-type: none"> a. If available and connected to the mains power supply: <ol style="list-style-type: none"> 1) This has higher priority and supplies the load (the LEDs) 2) The battery is charged and/or maintained in charge/floating. b. If no mains power supply is available or not connected: <ol style="list-style-type: none"> 1) The battery has higher priority and powers the load (the LEDs) 2) If the battery charge status falls below a certain threshold (SoC <20%), an alarm signal  (charge request) is displayed and the load is disconnected. <p>WARNING: To avoid excessive consumption of the 12V DC battery:</p> <ul style="list-style-type: none"> - Do not carry out continuous cycles of handling the pole. - Do not leave the unit in stand-by mode (no more than 100 hours); electronic devices would remain continuously powered. - If not intended for use, set de selector to "O". <ol style="list-style-type: none"> c. If the mains is restored and/or re-connected: <ol style="list-style-type: none"> 1) The load is supplied by the mains, 2) The battery is charged and/or kept in charge/floating mode
 Generator Only	<p>The system provides power to the load also in case the battery is disconnected or not available.</p> <ol style="list-style-type: none"> g. The battery is not managed (not charged or discharged) h. Mains input ignored i. The generator supply the load (the LEDs)



- Through the selector  it is possible to choose the desired control mode.

 Off	<p>Floodlights switched off. The LEDs are always switched off by turning the selector switch to the O position.</p>
 Manual	<p>The user manually switch ON/OFF the floodlights.</p>
 Light Sensor	<p>Floodlights status controlled as function of the environmental brightness, by using Light Sensor (preset value). The Light Sensor placed on the floodlights support detects the ambient brightness. Check that the sensor is clean and exposed to the ambient bright.</p>
 Timer	<p>Floodlights status controlled as per schedule timer settings. For more information, refer to the Timer manual.</p>

V20 V20 PRO iQ20

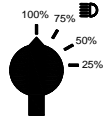

- Through the selector it is possible to choose the desired floodlights dimming:

100%	100% of the floodlights power
75%	75% of the floodlights power
50%	50% of the floodlights power
25%	25% of the floodlights power

- The battery storage charging procedure is controlled by means of the BATTERY MONITOR

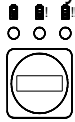

BMV that works as per indications below:

	The green lamp lights up when the load is supplied from the battery.
	The red lamp lights up when the battery is in charging phase (from mains or generator).
	The red lamp lights up when the State of Charge (SoC) of the battery is <20% and: <ul style="list-style-type: none"> no mains power supply is available the generator is faulty or there is no fuel

For complete description refer to the **BATTERY MONITOR BMV manual**.

For complete description refer to the **MPnano or DSE controller manual**.

V20 V20 PRO iQ20

11.13 RUNNING IN

For the first 50 hours of operation of the machine, to allow a good run-in of the engine, do not use more than 70% of the maximum power indicated in the technical specifications.

11.14 STABILIZERS

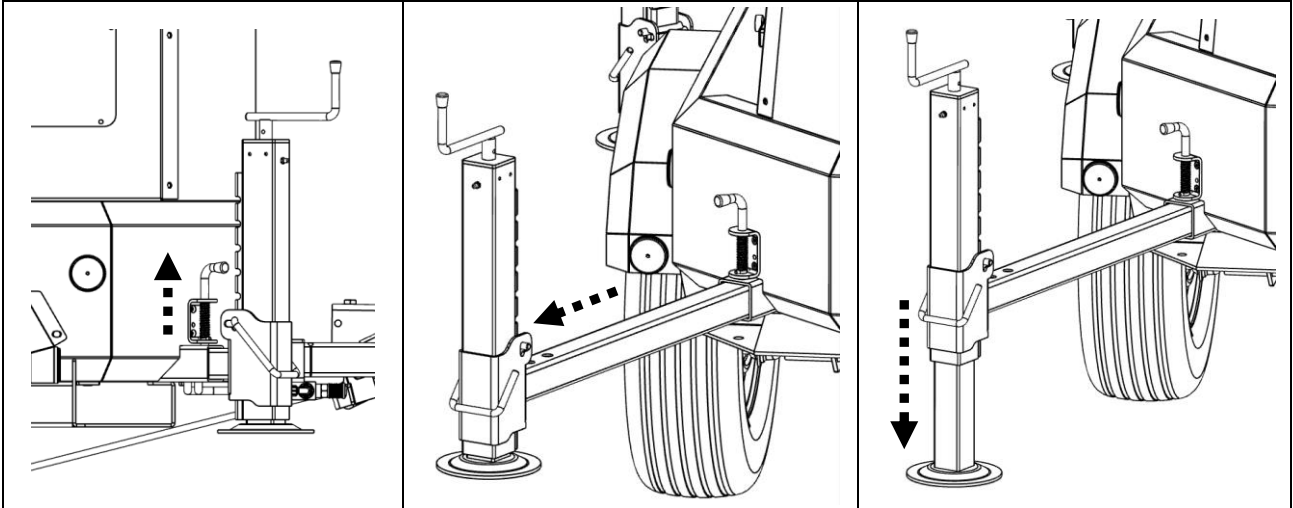

Extract the stabilizers, releasing the locking pins from their locations and manually pulling until the pins block the tube.

Verify that the pins enter the dedicated locking holes on the pipe.

Lower the stabilizers through the handle or through the rapid locking/unlocking system (if present).

Refer to the air levels to ensure the correct stability of the light tower.

WARNING! Do not raise the light tower mast if all the stabilizers are not properly deployed.

V20 V20 PRO iQ20

11.15 MAST ADJUSTMENT

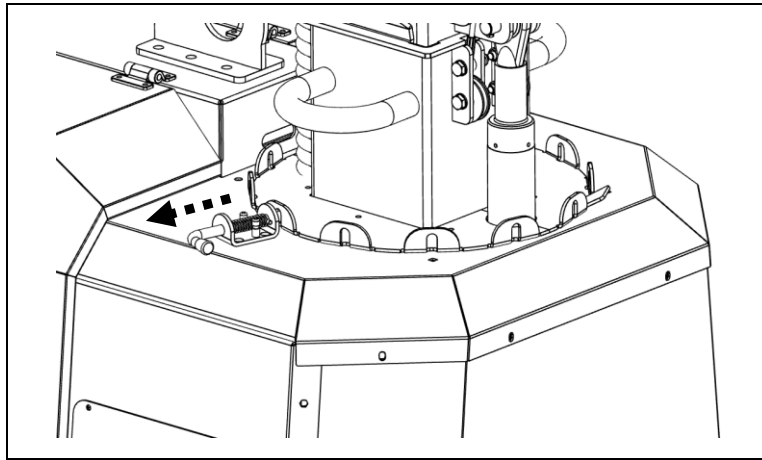

Deploy the stabilizers as described at the dedicated chapter.

WARNING! Do not raise the light tower mast if all the stabilizers are not properly deployed.

Pull the locking pin to allow the rotation of the mast. A handle on the side of the mast facilitates the rotation. Block the position of the mast by re-inserting the pin.

Start the engine as described at the dedicated chapter.

Raise the mast to the desired height by pressing the button .

A red band on the base of the mast indicates that the maximum height is reached.

WARNING! It is strictly forbidden to close the stabilizers when the mast of the light tower is upright at the maximum height.

WARNING! The light tower can withstand a maximum wind speed with the mast at the maximum height. Verify the maximum wind speed indication on the dedicated label placed on the machine's body. In case of stronger winds, be careful and lower the telescopic mast in a timely manner.

WARNING! It is strictly forbidden to modify any part of the light tower in order not to compromise its stability and functionality. If any part results to be damaged or altered, do not use the machine until the problem is solved, if necessary in collaboration with the manufacturer's staff.

After use, lower the mast pressing the button , until the telescopic sections are all retracted.

11.16 FLOODLIGHTS

Tilt the floodlights by loosening the lever/nut placed on the side of the floodlights, or simply aiming them in the desired position.

Rotate the floodlights until achieving the desired type of lighting and then tighten the lever/nut.

Switch on the lamps through the dedicated selector  or by pressing the relevant button on

the controller .

V20 V20 PRO iQ20

Direct the light beam by rotating the mast to the desired position. To facilitate rotation use the handle provided on the side of the mast.

11.17 ELECTRIC PROTECTION

- **RCD/MCB.**

The unit is equipped with an RCBO combined (RCD/MCB) device  that ensures protection of the user in the event of direct or indirect contact. In these cases, reference standard prescribes the automatic interruption of the power.

Warning!

In order for the RCD/MCB to work properly and in compliance with current regulations, the machine must be connected to the ground. Grounding must be in accordance with the prescriptions at the dedicated chapter.

Verify periodically the operation of the RCD/MCB, by pressing the 0 “TEST” button placed on the front panel.

The light tower and single-phase auxiliary socket  (if present) can be used at the same time. It is recommended not to exceed the plate data.

Use plugs that fit the socket and have the same characteristics.

The minimum section of the connection cable must be selected in relationship to the voltage, to the installed power and the distance between source and utility.

- **MCB**

For hydraulic gear box

Floodlights switch (only V20-iQ20)

Inverter charger (only V20 PRO)

V20 V20 PRO iQ20

- **ISOMETER (optional)**

The unit is provided with a insulation monitoring device (ISOMETER) that monitors the insulation resistance of the unearthed systems provided by single-phase generator (IT systems) and earth. live parts are not connected to earth or to protective conductor.

All the relevant metallic enclosures are collected, electrically-mechanically, to the main earth terminal (MET).

ISOMETER superimposed a measuring voltage to the IT system being monitored via terminals L1, L2 and KE/earth. Ohmic insulation faults close the measuring circuit between the IT system and earth.

The currently measured insulation resistance is shown on the display of the device. When the value of Measured Insulation Resistance (MIR) falls below the set thresholds and the response timer is expired, following actions are commanded:

- $MIR > 46 \text{ k}\Omega$

No action, safe condition, supply enabled to the load/LEDs;

- $23 \text{ k}\Omega < MIR < 46 \text{ k}\Omega$

Warning condition, supply to load/LEDs OFF, AL1 led on ISOMETER lits;

- $MIR < 23 \text{ k}\Omega$

Shutdown condition, supply to load/LEDs deactivated, AL1 and AL2 led on IRD 423 lit, engine shutdown, "external shutdown".



Warning!

Earthing arrangements shall be carry out as described in specific chapters.

Verify periodically the proper operation of the ISOMETER by pressing (hold > 1,5") the "TEST" button placed on the device.

11.18 STOPPING THE GENERATOR

Disconnect the loads.

Switch off all the lamps through the dedicated selector  or by pressing the relevant button on the controller .

To stop the engine, press the Stop button  on the controller or put in (O) position the selector .

In an emergency event, it is possible to stop the generating set by pressing the emergency stop button .

V20 V20 PRO iQ20

11.19 TIME OF INACTIVITY

If it is needed to keep the machine inactive for a long time (greater than one year), it is recommended to leave motor oil, coolant (if equipped with liquid cooling) and fuel inside the engine to avoid oxidation.

Battery cables should be disconnected. Before putting the machine back in operation, oil, coolant and fuel will need to be replaced.

Use the battery switches to disconnect and connect low voltage circuits.

The battery needs to be restored and belts, pipes, rubber joints and their seals will have to be inspected as well as the electrical wiring.

When stored, it is especially recommended to protect the machine from the exposure to rain, excessive humidity, sand or saline air in order to preserve its original conditions.

AGM STORAGE BATTERIES

Upon delivery of the mentioned products, the batteries must be charged on the mains to carry out a complete initialization.

IMPORTANT: the batteries are not fully charged until yellow “float” led is illuminated on multiplus II (inverter/charger)

If the storage batteries must be put at rest for a long period, carry out a 100% full charge before storage and perform refreshing charges every 4 weeks.

This to ensure and maintain the full storage battery capacity.

IF EQUIPPED WITH LITHIUM STORAGE BATTERIES:

To preserve the integrity of the storage battery it is mandatory to proceed as follows:

Prepare the unit for storage by performing 100% full charge.

Perform full charge every 3 months of inactivity. In the event that the machine restarts (after a period of inactivity) at a 100% level of charge, discharge the storage battery to 95% then recharge it to 100%.

Storage of the unit at rest should be done at ambient temperature between 5°C and 25°C (41°F and 77°F).

WARNING!!! Do not complying with the above recommendations could irreparably damage the battery.

V20 V20 PRO iQ20

12. MAINTENANCE

Description	Operation	Daily	Monthly
Engine	Make reference to the engine operator's manual		
Alternator	Make reference to the alternator operator's manual		
Machine cleaning	Clean		•
Stabilizers	Grease		•
Hydraulic cylinder	Check	•	
Hydraulic gear box	Check and refill if necessary	•	
Hydraulic connections	Check for oil leakage	•	
Steel cables	Check. Contact the manufacturer if necessary	•	

The extraordinary service operations not mentioned here require the aid of authorized technicians. For assistance contact a representative of the manufacturer.

12.1 ENGINE

In order to preserve the engine performance it is strongly recommended to follow the maintenance operations and the maintenance schedules reported in the engine operator's manual.

The hour counter  (if present) exclusively indicates the cumulative operation hours of the floodlights. Refer to the controller for the engine operating hours. It can be a reference for the ordinary and extraordinary maintenance of the machine.

12.1.1 ENGINE OIL CHANGE

Remove the oil drain plug placed on the bottom of the engine and drain all the oil.

If the machine is equipped with manual oil extraction pump, remove the discharge plug on the pump and connect a rubber hose (not supplied). Place the other end of the hose in a container, outside the enclosure of the machine. Unfit the oil cap and discharge the oil pumping it.

WARNING! Once finished using the pump, tighten the discharge plug well and verify the tightening before every engine start.

Draining the oil completely is easier when the engine is hot.

Contact with motor oil can be harmful to the skin. Wear gloves before using oil. If you come in contact with oil, wash the part immediately.

Verify oil change intervals and oil type in the engine use and maintenance manual, provided with the light tower.

If not specified in the present manual verify oil/oil filter change intervals and oil type in the engine use and maintenance manual, provided with the light tower.

Engine	Oil/oil filter change interval
Kubota Z482 StageV	1000h ⁽¹⁾ ⁽²⁾
Yanmar 2TNV StageV	500h ⁽¹⁾ ⁽²⁾
⁽¹⁾ Valid only if engine combined duty ratio is <50%. Duty ratio is the proportion of time in which the engine will operate at one or multiple load conditions.	
⁽²⁾ For hybrid units is valid only if used in Generator mode.	

Do not discharge polluting fluids in the environment.

V20 V20 PRO iQ20

12.2 ALTERNATOR

In order to preserve the alternator performance it is strongly recommended to follow the maintenance operations and the maintenance schedules reported in the alternator operator’s manual.

12.3 MACHINE CLEANING

We suggest a frequent cleaning of the machine in order to avoid dirt deposits that may compromise its efficiency.

DO NOT wash the unit with high pressure hoses, power washers, or steam cleaners. Water may collect in unit, causing damage to electrical parts.

12.4 STABILIZERS

Grease periodically the stabilizer using a dense grease adapted to sliding system using a lubricator to be inserted into the valves on the stabilizer (if present). Check that the stabilizers are moving smoothly.

12.5 HYDRAULIC CYLINDER

Periodically check the condition of the hydraulic cylinder, checking that there are no traces of wear, chafing, cracks or corrosion.

12.6 HYDRAULIC GEAR BOX

Periodically check the level of hydraulic oil. Only top up if the level drops below 3 liter. The check must be carried out after at least 30 minutes after switching off the engine and with the telescopic mast lowered.

In the case of topping up or replacement only use hydraulic oils with very high viscosity index and suitable to use temperatures ranging from **+46°C** e **-46°C**. We recommend the use synthetic oil obtained by chemical synthesis from not petrochemical raw materials sources comes from renewable, biodegradable and fire resistant, conforming to DIN 51524 teil 2, ISO HVI specifications. It is sufficient introduce in the tank about 3 l of oil.

Always use protective gloves when changing and checking the engine oil level.

12.7 HYDRAULIC CONNECTIONS

Periodically check the various fittings and pipes of the hydraulic oil from the tank to the cylinder for signs of wear or cuts. Check for oil leakage.

12.8 STEEL CABLES

Periodically check the condition and the perfect dragging of the steel cables inside the pulleys. If cables and pulleys are replaced, check that they are installed correctly. If the steel cables show signs of wear (refer to table below), do not use the unit and contact directly the manufacturer. Although in good condition, we recommend the replacement of the steel cables, after 10 years from the date of production.

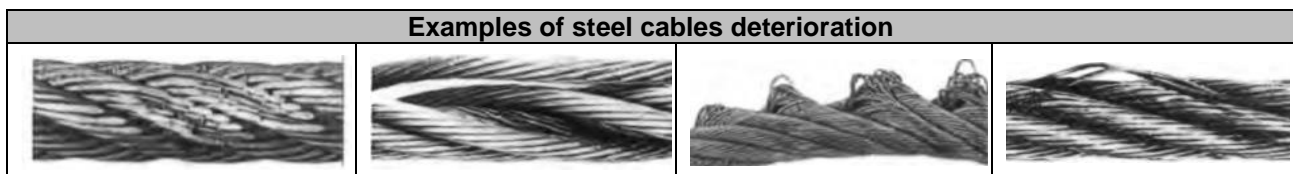

V20 V20 PRO iQ20

13. TROUBLESHOOTING

The most common issues related to the use of a light tower and possible remedies are reported below.

If the engine does not work correctly or controller displays alarms or error messages, refer to the specific chapter in the dedicated manual, provided with the light tower.

13.1 TROUBLESHOOTING GUIDE

ANOMALY	CAUSE	REMEDY
The controller does not work	The battery is disconnected.	Open the door and connect the battery.
	The battery is out of charge.	Charge the battery.
	The battery is defective.	Replace the battery.
	The starting motor does not work.	Contact an assistance center of the engine manufacturer for a check.
	The emergency stop button is pressed.	To re-arm it, turn the button clockwise.
	There are disconnected cables in the electrical system.	Visually check the electrical system to find the disconnected cables (refer to the wiring diagram), if necessary contact directly the manufacturer.
The starting motor works but the engine does not start.	The fuel level in the tank is too low.	Refuel the machine.
	Fuel filter dirty.	Replace the filter.
	The fuel pump does not work.	Verify the electrical connection of the pump and if necessary contact an assistance center of the engine manufacturer for a check.
Starting the engine is difficult, insufficient performance.	The air filter is dirty.	Clean the air filter or replace it.
	Injection pump wear.	Do not use poor quality fuel as it might cause wear of the pump. Check the fuel injection pump element and replace it if necessary.
	Overheating of moving parts.	Check the lubricating oil system. Check to see if the lubricating oil filter is working properly or replace it.
Output voltage unstable.	Irregular engine speed.	The engine is set at the correct speed (1500 r.p.m. 50 Hz - 1800 r.p.m. 60 Hz), in case of unsettling contact the manufacturer.
	The alternator is faulty.	Replace the alternator or contact the manufacturer.
The machine stops with low oil pressure warning.	The oil level is low.	Verify the level and add oil if necessary.
	The pressure switch is faulty.	Replace the pressure switch.
The machine stops with high water temperature warning.	The level of the coolant in the radiator is low.	Verify the level and add coolant if necessary.
	Radiator grille or radiator fins clogged with dust.	Clean the grille or fins carefully.
	The radiator fan does not work.	Check the fan.

V20 V20 PRO iQ20

The machine stops with battery charge warning.	The battery is defective.	Replace the battery.
	The engine's alternator is faulty.	Check the engine's alternator and if necessary contact an assistance center of the engine manufacturer.
After refueling, the fuel level indicator does not move.	The fuel level gauge is faulty.	Check the fuel level gauge and its electrical connection.
	The float does not work.	Check the float and its electrical connection. If the level sensor is stuck and cannot be moved, replace it.
The automatic earth leakage relay trips during the use of the machine.	A current leak occurred while using the auxiliary socket.	Check the electrical system connected to the auxiliary socket, verify that the connected power does not exceed the plate data.
	Electrical connections interrupted.	Check the external electrical system and contact the manufacturer if necessary.
	No connection to earth or connection to earth not correct.	Verify that connections to earth respect the prescriptions.
With engine running, the hour meter does not work.	The hour meter is faulty.	Check the hour meter and its electrical connection.

V20 V20 PRO iQ20

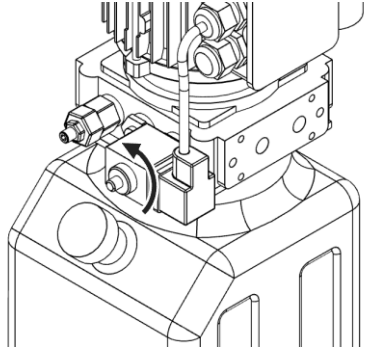
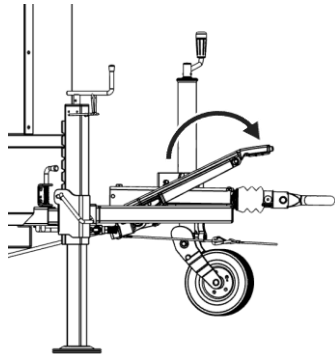
<p>The raising and lowering button of the telescopic mast does not work.</p>	Defective electrical connection.	Check the electrical connection.
	<p>The hydraulic gear box does not work.</p>	Check that the RCD/MCB is armed, eventually rearmed it.
		Check the electrical system of the hydraulic gear box.
		Check the oil level of the hydraulic gear box, top up if necessary.
		Replace the hydraulic gear box contacting directly the manufacturer.
	<p>The hydraulic gear box is failure.</p>	<p>Unscrewing the pin in counter clockwise direction, it is possible to lower the mast.</p>  <p>Retighten the pin after the mast is lowered.</p>
<p>If the machine is equipped with AMOSS KIT (Automatic Mast Operating Safety System) it is possible to lower the mast by lowering the handbrake of the road trailer.</p> 		
<p>The telescopic mast sections are stuck.</p>	<p>Refer to the spirit level to check that the machine is level. If necessary, adjust the inclination using the stabilizers.</p>	
	<p>Contact directly the manufacturer.</p> <p>WARNING:</p> <p>If the mast does not lower, DO NOT press insistently the lowering button and DO NOT touch the telescopic sections with your hands.</p>	